

When fully executed return to:

Pinal County
Clerk of the Board
135 North Pinal Street
Florence, AZ 85132

**1st Amendment to Public Right-of-Way Use Agreement (Fiber-Based
Small Wireless Network)**
(Access to Right-of-Way)

This 1st Amendment to the Public Right of Way Use Agreement (this "AMENDMENT") is entered into effective as of this _____, day of _____, 2024 ("Effective Date"), by and between Crown Castle Fiber LLC, a New York limited liability company ("**Crown Castle**") and Pinal County, a political subdivision of the State of Arizona (the "**County**"). Crown Castle and County are sometimes hereinafter referred to individually as a "**Party**" and collectively as the "**Parties**".

RECITALS

- A. Crown Castle and County have entered into a Public Right-of-Way Use Agreement for Fiber-Based Small Wireless Networks, Access to Right-of-Way ("**Original Agreement**") on June 19th, 2024, Pinal County Fee Number _____, for the purposes of allowing fiber optic telecommunications lines within the County's right-of-way; and,
- B. Crown Castle owns, manages, operates, and markets certain communications networks (collectively, "**Networks**") as a telecommunications provider certificated by, and subject to the jurisdiction of the Arizona Corporation Commission; and,
- C. In conjunction with the construction and operation of its Networks, Crown Castle wishes to access the County's right-of-way ("**ROW**") for the placement of telecommunications equipment including but not limited to cables, primer, sealant, and equipment for the operation of its Networks ("**Equipment**"); and,
- D. Crown Castle completed a demonstration project using the Rapid Connect method to install Equipment in specified locations within the right of way owned by a neighboring jurisdiction; and,
- E. Crown Castle and the County now desire to define the rights, duties, and obligations between the Parties related to Crown Castle's installation of Equipment via Rapid Connect methods for use within the ROW for Crown Castle's Rapid Connect program for and the County's authorization of such installations;

AGREEMENT

NOW THEREFORE, in consideration of the mutual covenants contained herein and intending to be legally bound, the parties agree as follows:

1. **Access.** Crown Castle must submit plans and Equipment specifications and apply for a County encroachment permit (i.e. Right of Way Use Permit) to access the ROW for the installation of its Equipment in accordance with County requirements ("County Standards"). Prior to accessing any

portion of the ROW, Crown Castle shall comply with all terms of this AMENDMENT and the County shall, in due course, issue any necessary encroachment permits provided the proposed improvements conform to the methods and specifications detailed in Exhibit A, the County Standards, and all applicable County Standard Construction Drawings and Specifications ("County Standards").

2. Authorized Use. The Parties acknowledge that the purposes of this AMENDMENT are to:
 - a. Authorize Crown Castle to utilize Rapid Connect construction methods to install Equipment within the ROW. Crown Castle's maintenance and operation of its Equipment and Networks installed through Rapid Connect shall be subject to the terms of any applicable permits, laws, and County Standards.
 - b. Pursuant to 2(a) Crown Castle will reserve four (4) fiber optic strands for use by the County. County's use of fiber optic strands may be subject to a subsequent lease agreement between the Parties.
3. Rapid Connect Specifications. Crown Castle shall install its Equipment in the ROW in accordance with the methods and specifications detailed in Exhibit A , County Standards, and as directed by the Pinal County Engineer.
4. Vaults. Vaults to be used as termination or access points for the micro ducts as detailed in Exhibit A shall be installed outside of the ROW and within the adjacent Public Utility Easement to the maximum extent possible. Vaults installed in the ROW shall be shown on the plans submitted with encroachment permit applications, installed in accordance with applicable County Standards, and as directed by the Pinal County Engineer. .
5. Restoration. In connection with its use of Rapid Connect methods to install Equipment and Networks in the ROW, Crown Castle shall restore the ROW on roads and any other County property on which it has installed Equipment immediately following installation in accordance with the specifications set forth in Exhibit A, County Standards, and as directed by the Pinal County Engineer. Crown Castle shall complete the construction and restoration of a particular permitted Rapid Connect segment within 90 days from the pre-construction meeting.
6. Costs. Crown Castle shall be responsible for all costs related to the installation of its Equipment under this AMENDMENT. The County shall have no obligation to perform or pay for any work required for the installation, maintenance, or operation of Crown Castle's Equipment or Networks at any location in the ROW, unless agreed to by both parties under separate written agreement pursuant to Section 2.b of this AMENDMENT.
7. Crown Castle Contractors. Crown Castle shall only use licensed, qualified, and trained persons for any and all work performed pursuant to this AMENDMENT. Crown Castle and its contractors shall obtain all necessary licenses and follow any procedures the Parties have mutually agreed upon prior to performing work. Crown Castle must cause or begin to cause the release of any mechanics lien or stop notice by any Crown Castle contractor or supplier purporting to attach a lien to the property installed under this AMENDMENT within 30 days of notice or discovery of the lien. Upon failure to do so, the County will have the right, but not the obligation, to cause the lien to be released by any means it deems proper, including payment of the claim giving rise to the lien, for which Crown Castle shall reimburse the County within 30 days following receipt of the County's demand. In addition to, and notwithstanding the foregoing, Crown Castle shall also reimburse the County for all reasonable, actual, and documented expenses incurred in connection with any such lien (including reasonable attorneys' fees) within 30 days following receipt of the County's demand.
8. Insurance.
 - A. Required Coverages. Crown Castle shall maintain at its expense Commercial General Liability Insurance with a limit of at least \$1,000,000 per occurrence and a \$2,000,000 general and

completed operation aggregate. Coverage shall include excess liability coverage of at least \$5,000,000. Crown Castle shall provide a certificate of insurance to the County evidencing the County as a certificate holder. Crown Castle shall also maintain Auto Liability Insurance in an Agreement of \$1,000,000 combined single limit for bodily injury and/or property damage. Crown Castle shall maintain Workers' Compensation Insurance in the statutory amount with Employer's Liability coverage of \$1,000,000 per accident or disease and in aggregate. Crown Castle's liability under this AMENDMENT is not in any way limited to or affected by the Agreement of insurance coverage required or carried by the Crown Castle in connection with this AMENDMENT.

B. Endorsements. The General Liability Insurance and Auto Liability Insurance policies must contain the following endorsements or provisions:

- (1) include the County, its officers, agents, employees, and volunteers as additional insureds;
- (2) that such policies are primary insurance to any other insurance available to the additional insureds with respect to any claims that arise in connection with this AMENDMENT or the encroachment permit;
- (3) waiver of rights of recovery or subrogation against the County, its officials and employees
- (4) that such insurance applies separately to each insured against whom a claim is made or brought, except with respect to the limits;
- (5) that such policies provide for the severability of interests and that an act or omission of one of the named insureds that would void or otherwise reduce coverage shall not void or otherwise reduce coverage as to any other named insured; and
- (6) that such policies shall afford coverage for all covered claims based on acts, omissions, injury, or damage that occurred or arose (or the onset occurred or arose) in whole or in part during the policy period. No additional insured endorsement shall exclude products/completed operations.

C. Other Requirements.

- (1) Cancellation Notices. Licensee shall provide at least 30 days prior written notice to the County of cancellation and 10-day notice for non-payment of premium. If replaced with insurance from a different qualified insurer, Licensee shall provide an updated certificate of insurance to the County within 15 days.
- (2) Claims-Made Policies. In the event that any required insurance under this AMENDMENT is provided under a claims-made form, Crown Castle shall continuously maintain such coverage throughout the term of this AMENDMENT, without lapse, and for three years after this AMENDMENT expires or terminates. Should any event give rise to a claim brought after this AMENDMENT expires or terminates, such Claims will be covered under Crown Castle's claims-made policies.
- (3) Insurer Qualifications. Licensee's insurance providers must be eligible to do business in Arizona and must meet or exceed an A.M. Best's Key Rating A-VI or its equivalent.

9. Indemnification. Crown Castle shall indemnify, defend, and hold harmless the County, and its officers, officials, employees, agents, contractors, and volunteers against any claim of liability or loss, including but not limited to any claim of liability or loss, from any bodily injury, death, and/or property damage brought by a third party to the extent resulting from or arising out of Crown Castle's and/or any of its contractors, servants, agents or invitees acts or omissions to the extent related to or arising from Crown Castle's work in, or the presence of the Network or Equipment in, the ROW, including, but not limited to any claim of liability or loss associated with any Hazardous

Material excepting only claims or damages caused by the sole negligence or willful misconduct of the County, or its officers, officials, employees, volunteers, subcontractors, servants, agents or invitees. The term "Hazardous Material" includes any material or substance defined as a "hazardous substance," "pollutant," "contaminant," or "hazardous waste," as defined in the Comprehensive Environmental Response, Compensation and Liability Act and any regulations promulgated pursuant thereto, the Clean Water Act and any regulations promulgated pursuant thereto, or Sections 25316 and 25140 of the California Health and Safety Code, or other environmental protection laws.

10. Compliance. Crown Castle shall comply with all laws, statutes, ordinances, rules, and regulations, which are applicable to its work in the ROW and the installation, maintenance, and operation of its Equipment. Crown Castle specifically recognizes that further permissions and permitting from the County may be required for any excavation in the ROW for the installation of the Equipment. County shall comply with all laws, statutes, ordinances, rules, and regulations, which are applicable to this AMENDMENT.
11. Relocation.
 - A. Public Projects. At no cost to the County, Crown Castle shall relocate or adjust its Equipment as required in connection with any future improvements constructed by or on behalf of the County in the ROW ("Public Project") which materially conflict with the Equipment, as requested in writing by the County within a reasonable time under the circumstances. Except as outlined in paragraph B of this Section, any costs related to projects other than County Public Projects (or the public projects of another public agency) which require the relocation or adjustment of Crown Castle Equipment shall be borne by the applicable private entity funding the project, to the extent such costs may be imposed on the private entity under applicable law. If there is no such private entity, such costs shall be the sole responsibility of Crown Castle to the extent such costs are not borne by the private entity.
 - B. Material Disruption of Public Services. If Crown Castle's authorized installation of Equipment via Rapid Connect methods results in the material disruption of public services provided by the County at a specific location/along a specific route within the ROW, and such disruption is evidenced by repeated, documented official notifications provided to Crown Castle pursuant to applicable permits, laws and County Standards, then at no cost to the County, Crown Castle shall relocate or adjust its Equipment at that specific location/along that specific route. In conjunction with any such relocation or adjustment, Crown Castle shall make all necessary repairs to the pavement to restore it to the original condition. Any plan for relocation or adjustment of Crown Castle's equipment due to material disruption of the provision of public services shall be negotiated by the Parties in good faith and shall be mutually agreed upon by the Parties prior to Crown Castle undertaking such activity.
 - C. Relocation Assistance. Should Crown Castle seek to relocate the Equipment, the County will use reasonable effort to accommodate Crown Castle's request for relocation at Crown Castle's sole expense. Nothing in this AMENDMENT creates any right to relocation assistance under the Arizona Relocation Assistance Law (A.R.S. §§ 8-461 et seq. and 11-961 et seq.), the Uniform Relocation Assistance and Real Property Acquisition Policies Act (42 U.S.C. §§ 4601 et seq.) or similar law. To the extent that any relocation law may apply, Crown Castle waives, releases, and relinquishes forever any and all claims that it may have against the County for any compensation from the County.
12. Term. This AMENDMENT shall remain effective unless either Party notifies the other Party of its intent to terminate the AMENDMENT by providing 180 days' prior written notice of termination.

Notwithstanding the foregoing, in the event of such termination of this AMENDMENT, any projects to install Equipment for which Crown Castle has applied for permits or authorizations shall be duly considered by County and may be allowed to continue, at County's sole discretion, to full completion using traditional construction methods other than Rapid Connect.

13. Assignment.
- A. Crown Castle will be permitted to assign this AMENDMENT (a "Permitted Assignment"), without the County's prior consent but with notice to the County as provided below, to: (i) Crown Castle's parent; (ii) Crown Castle's subsidiary; (iii) an entity that acquires all or substantially all of Crown Castle's assets in the market (as the market is defined by the FCC under an order or directive of the FCC); (iv) an entity that acquires Crown Castle by a change of stock ownership or partnership interest; or (v) an entity controlled by Crown Castle or that, with Crown Castle, is under the common control of a third party.
 - B. A Permitted Assignment is subject to all the following conditions: (a) Crown Castle provides the County within 30 days of the effective date of Permitted Assignment, stating the contact information for the proposed Assignee; and (b) Crown Castle is in good standing under this AMENDMENT.
 - C. No Permitted Assignment will relieve Crown Castle of any obligation arising under this AMENDMENT prior to the assignment, unless expressly provided in writing by the County. Any assignment not in compliance with this Section 13 will be void and a material default by Crown Castle without a requirement for notice and a right to cure.
 - D. Any assignee shall assume all Crown Castle's obligations under this AMENDMENT and the encroachment permit.
14. Notice. All written notices, demands, or other correspondence required to be given to the County or Crown Castle must be written and delivered through: (a) an established national courier service that maintains delivery records and confirmations; (b) hand delivery; or (c) certified or registered U.S. Mail with prepaid postage and return receipt requested to the addresses below. All written notices under this AMENDMENT will be deemed to have been delivered when properly sent: (i) five days after deposit if delivered by first class mail; (ii) two days after deposit if delivered by certified mail; (iii) the date delivery is made by personal delivery or overnight delivery; or (iv) the date an attempt to make delivery fails because a party has failed to provide notice of a change of address or refuses to accept delivery. Telephone, facsimile and email information are provided for convenience and for couriers who may require such information, and any written notice given solely through electronic means will not be deemed to be effective notice. Any copies required to be given constitute an administrative step and not actual notice. The parties may change the notice addresses and other contact information above from time-to- time through written notice to the addresses above or the then-current notice address. All notices shall be addressed to Crown Castle and County set forth below, or to such other address or addressee as any Party entitled to receive notices under this Agreement shall designate, from time to time, by notice given to the others in the manner provided in this Section.

If to Crown Castle: Crown Castle Fiber LLC
 Attn: Legal Infrastructure
 2000 Corporate Drive
 Canonsburg, PA 15317

With a copy to: Crown Castle Fiber LLC
 Attn: Douglas Patterson
 2055 S. Stearman Dr

Chandler, AZ 85286

If to County: Clerk of the Board
Pinal County Supervisors
PO Box 827
Florence, AZ 85132

With a copy to: Pinal County Development Services
Attn: County Engineer
PO Box 749
Florence, AZ 85132

15. Amendments. No part of this AMENDMENT may be changed, waived, discharged, or terminated orally, nor may any breach thereof be waived, altered, or modified, except by prior written AMENDMENT.
16. Counterparts. This AMENDMENT may be executed in two or more counterparts, each of which shall be deemed an original, but all of which collectively will constitute one and the same instrument. Delivery of an executed counterpart signature page by electronic transmission shall be effective.
17. Survival and Severability. Any provision contained within the AMENDMENT which by its very nature is intended to survive termination of the AMENDMENT shall survive such termination. If any provision of this AMENDMENT is held to be invalid, illegal or unenforceable in any jurisdiction, for any reason, then, to the fullest extent permitted by law, all other provisions hereof will remain in full force and effect in such jurisdiction and will be liberally construed in order to carry out the intent of the parties hereto as nearly as may be possible, and such invalidity, illegality or unenforceability will not affect the validity, legality or enforceability of any other provision hereof. Any court or arbitrator having jurisdiction over this AMENDMENT shall have the power to reform such provision to the extent necessary for such provision to be enforceable under applicable law.
18. Applicable Law. This AMENDMENT shall be governed by the laws of the State of Arizona and applicable federal law. Any action concerning this AMENDMENT must be brought and heard in Superior Court for the County of Pinal or in the United States District Court for the District of Arizona.
19. Entire Agreement. This AMENDMENT in conjunction with the Right of Way License Agreement entered into between the Parties constitute the entire agreement between the Parties with respect to the subject matter hereof and supersedes all prior or contemporaneous oral or written communications or understandings, or agreements between the Parties with respect to such subject matter. Moreover, this Amendment hereby amends and supplements the Original Agreement to include Crown Castle's Rapid Connect methodology as an approved method for installation of fiber optic telecommunications lines in the County's ROW. In the event of any conflict between the terms of the Original Agreement and this AMENDMENT, this AMENDMENT shall control for any matter relating to any installment, maintenance or removal of Rapid Connect equipment or facilities, the Original Agreement shall control in all other situations. In no event shall preprinted terms or conditions found on any purchase order, work order, online terms, or similar document issued by County or Crown Castle be considered part of, or an amendment or modification to, this AMENDMENT.

IN WITNESS WHEREOF, the parties have caused this Agreement to be executed as of the date first above written, intending to be legally bound hereby.

CROWN CASTLE:

Crown Castle Fiber LLC

By: Angela McIntyre
Name: ANGELA MCINTYRE
Title: DIRECTOR
Date: 6-20-24

State of Arizona)

) SS

County of Pinal)

This instrument was acknowledged before me this 20 day of June 2024,
by Angela McIntyre

Amanda Abelein

Notary Public

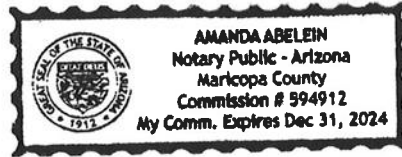

My Commission Expires:

12/31/2024

COUNTY:

PINAL COUNTY, a political subdivision of the State of Arizona

By: _____

Name: _____

Title: _____

Date: _____

Attest:

Clerk/Deputy Clerk of the Board of Supervisors

Approved as to form:

Deputy County Attorney

EXHIBIT A

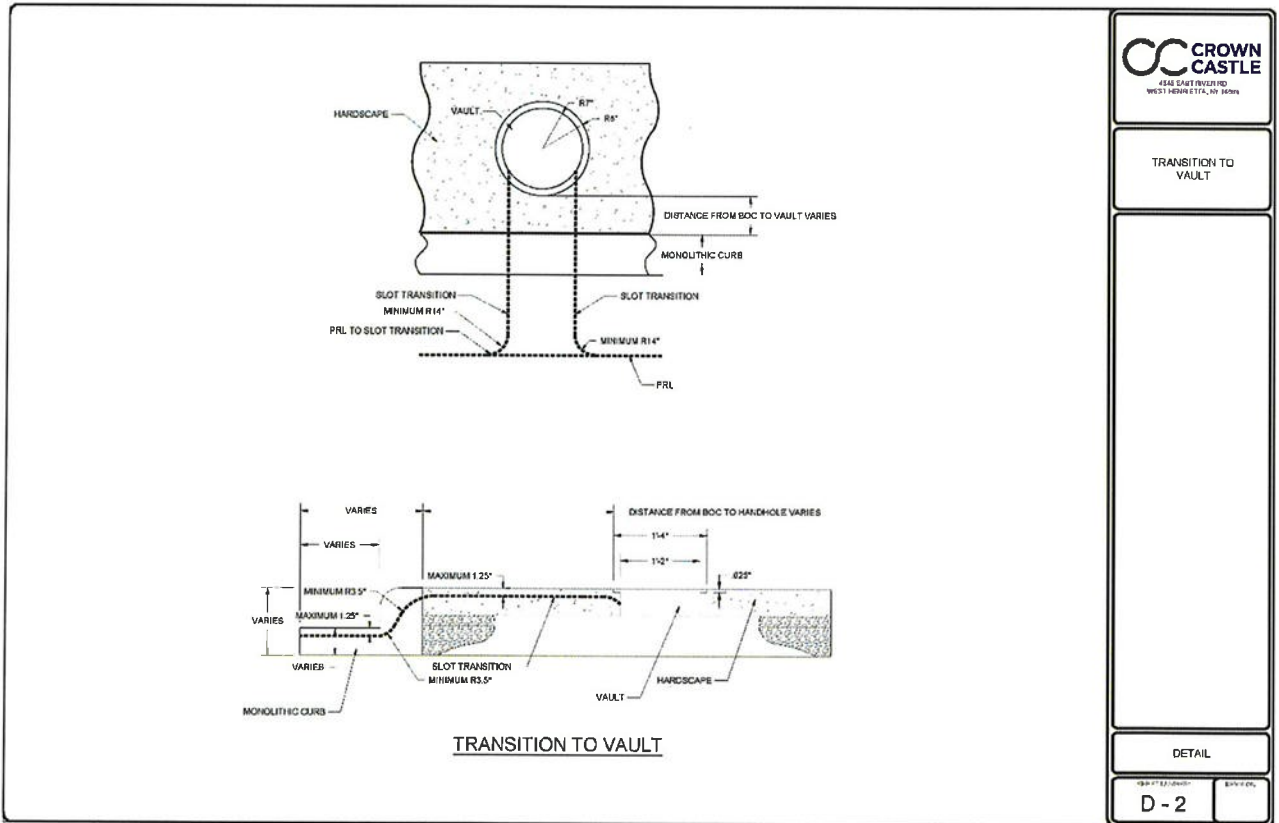
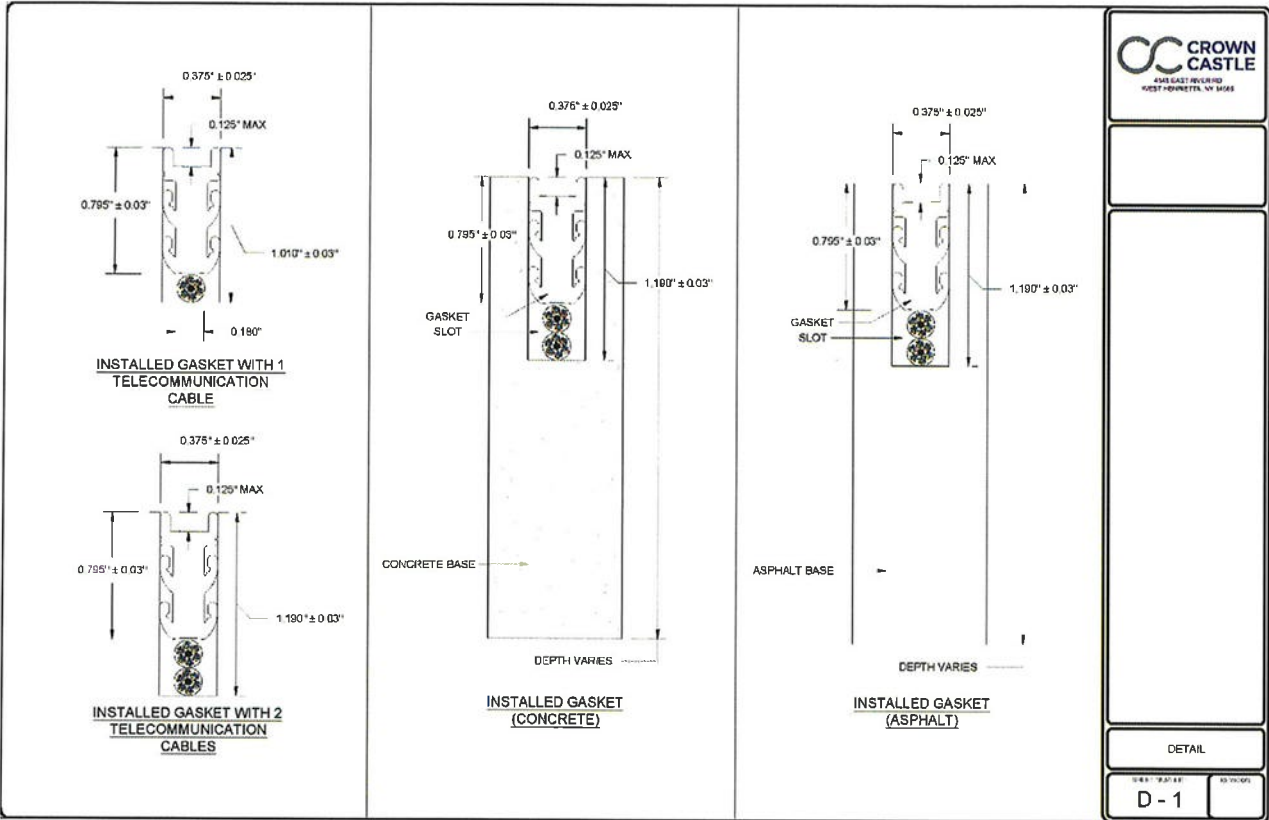

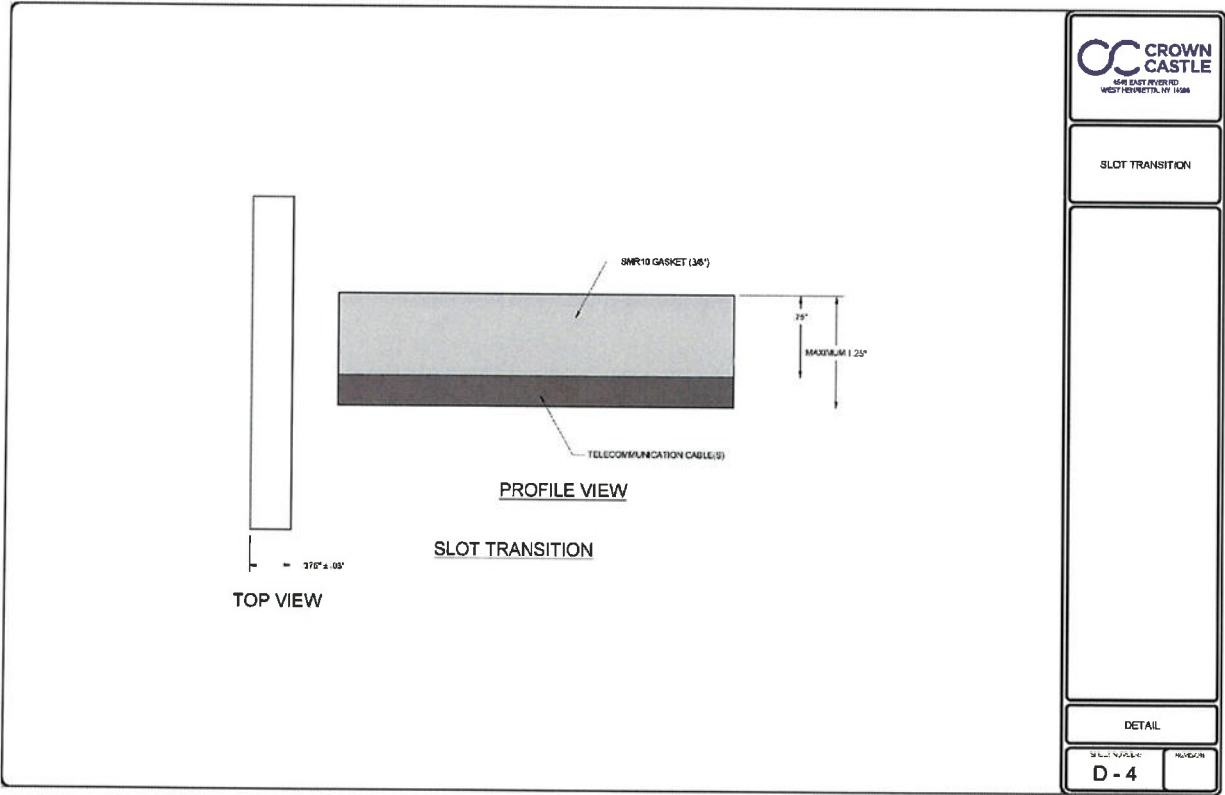
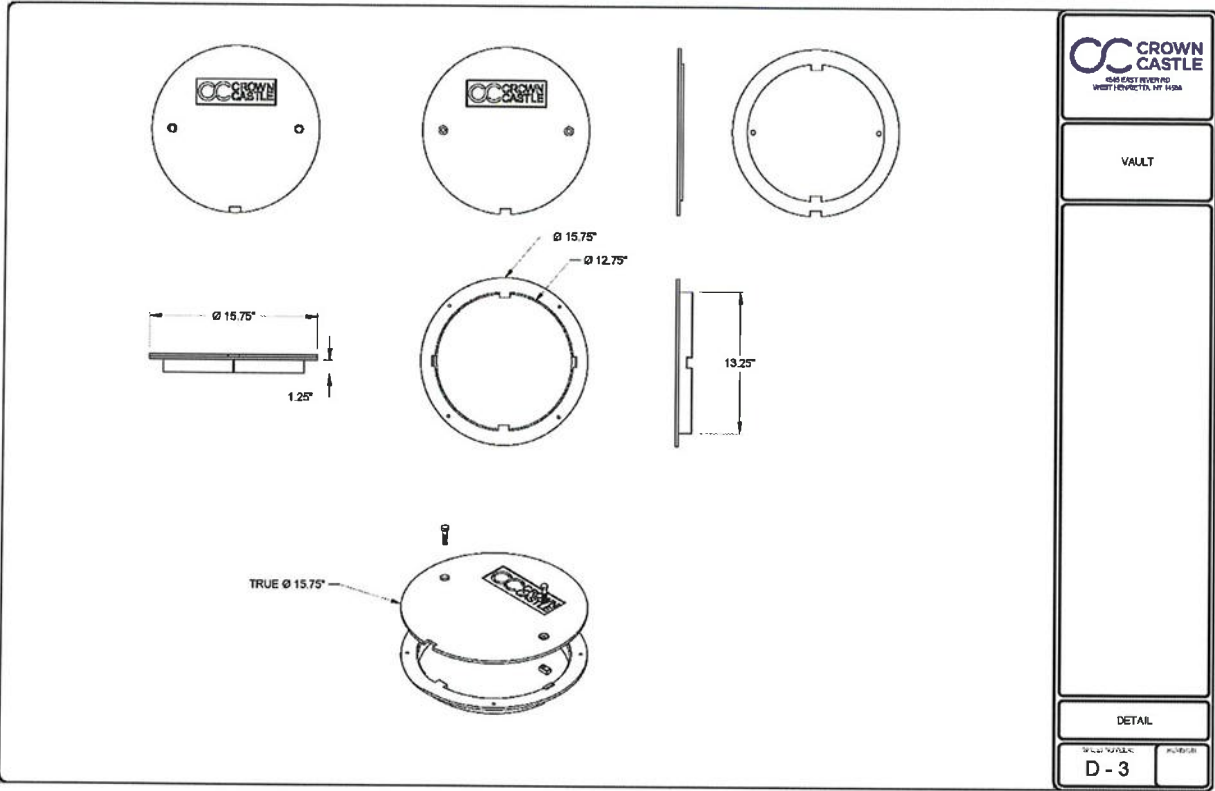

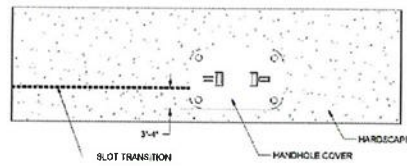
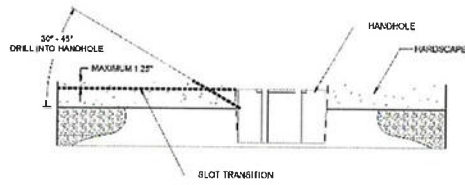

**SINGLE POINT ENTRY
 INTO TRADITIONAL
 HANDHOLE HARDSCAPE**

DETAIL

D - 5

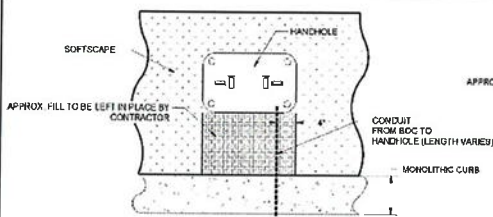

SINGLE ENTRY

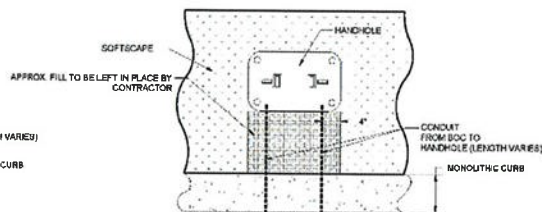

MID-SPAN ENTRY

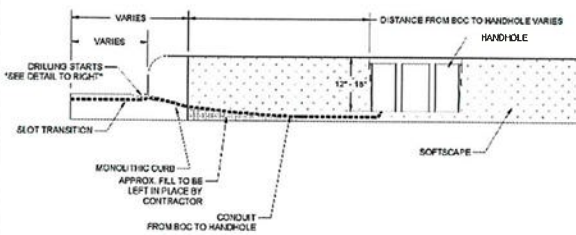

**SINGLE/MID-SPAN POINT
 ENTRY INTO
 TRADITIONAL HANDHOLE
 SOFTSCAPE**

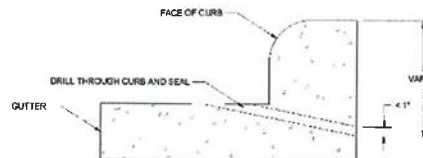

**SINGLE POINT ENTRY
 INTO TRADITIONAL
 HANDHOLE
 CURB-SOFTSCAPE**

DETAIL

D - 6

SINGLE POINT ENTRY INTO
 TRADITIONAL SOFTSCAPE

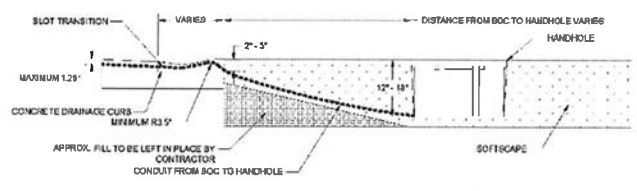

**SINGLE POINT ENTRY INTO
 TRADITIONAL SOFTSCAPE
 (CONCRETE DRAINAGE
 CURB)**

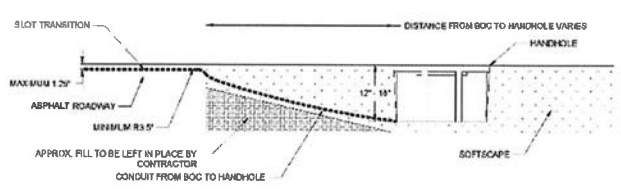

**SINGLE POINT ENTRY INTO
 TRADITIONAL SOFTSCAPE
 (ASPHALT)**

DETAIL

D-7

SPEED BUMP

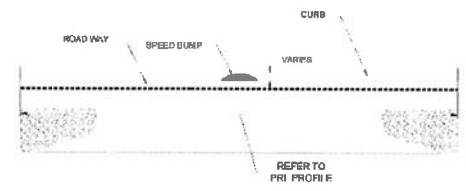
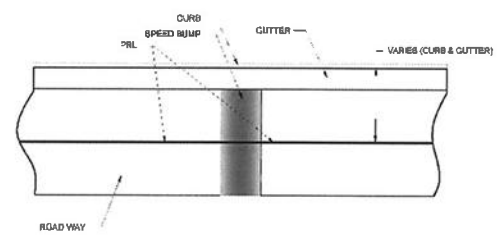

SPEED BUMP

DETAIL

D-8

DELTA TRANSITION TO VAULT

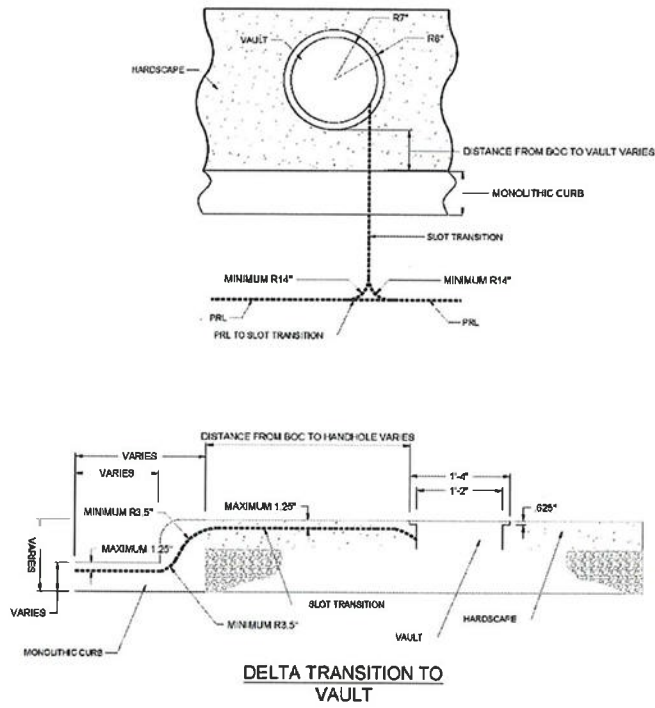

GRANITE CURB BRICK GUTTER TRANSITION

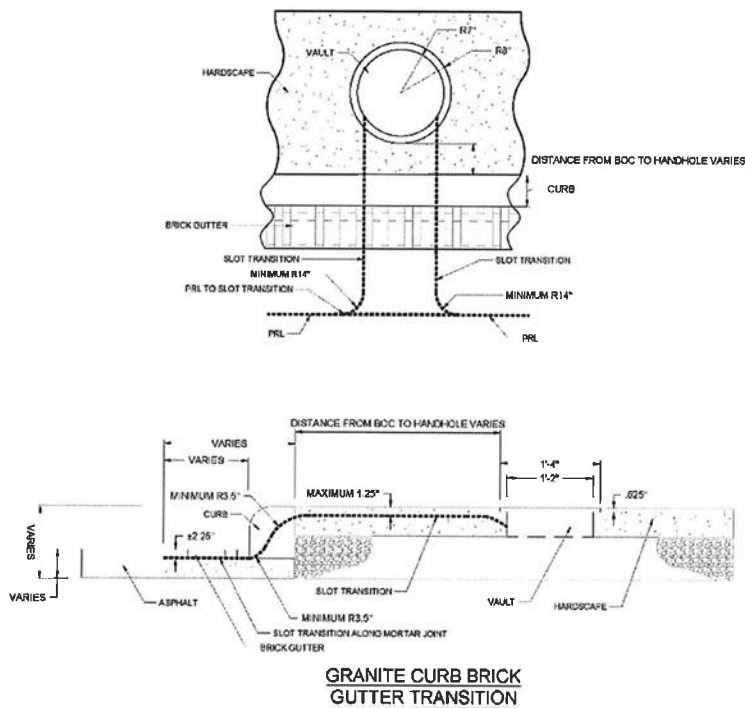

**EXPANSION JOINT
CROSSING BACKER ROD**

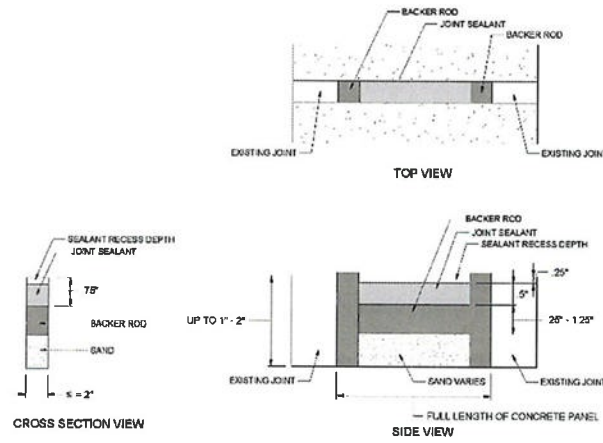

**EXPANSION JOINT
CROSSING BACKER ROD**

DETAIL
D - 11

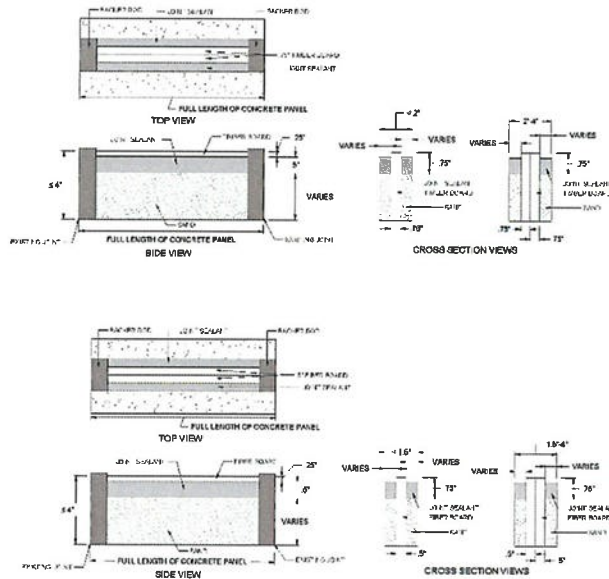

**EXPANSION JOINT
CROSSING
TIMBER/FIBER BOARD**

**EXPANSION JOINT
CROSSING TIMBER/FIBER BOARD**

DETAIL
D - 12

DUAL PATHWAY
 TRANSITION

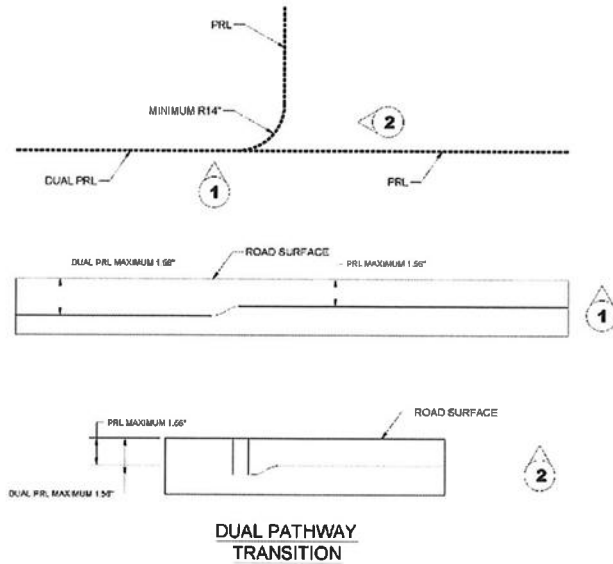

DETAIL

Sheet Number
D - 13

Page No.